

Foundations of Computer Science

Second Edition

BEHROUZ FOROUZAN

FIROUZ MOSHARRAF

Chapter 1 Introduction

Outlines

- Turing Model
- von Neumann Model
- Computer Components
- History
- Social and Ethical Issues
- Computer Science as a Discipline

Objectives

After studying this chapter, the student should be able to:

- Define the Turing model of a computer.
- Define the von Neumann model of a computer.
- Describe the three components of a computer: hardware, data, and software.
- List topics related to computer hardware.
- List topics related to data.
- List topics related to software.
- Discuss some social and ethical issues related to the use of computers.
- Give a short history of computers.

1-1 Turing Model

Data Processors

- A computer acts as a black box that accepts input data, processes the data, and creates output data.

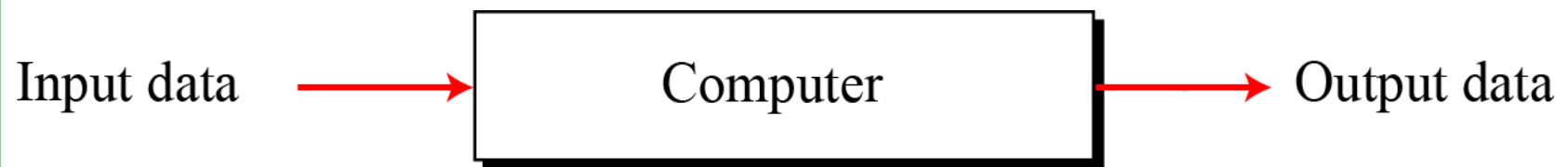

Figure 1.1 A single purpose computing machine

Programmable Data Processors(1)

- The idea of a universal computational device was first described by **Alan Turing** in 1937.
- He proposed that all computation could be performed by a special kind of a machine, now called a **Turing machine**.

Programmable Data Processors(2)

- The **Turing model** is a better model for a general-purpose computer. This model adds an extra element to the specific computing machine: **the program**. A program is a set of instructions that tells the computer what to do with data.

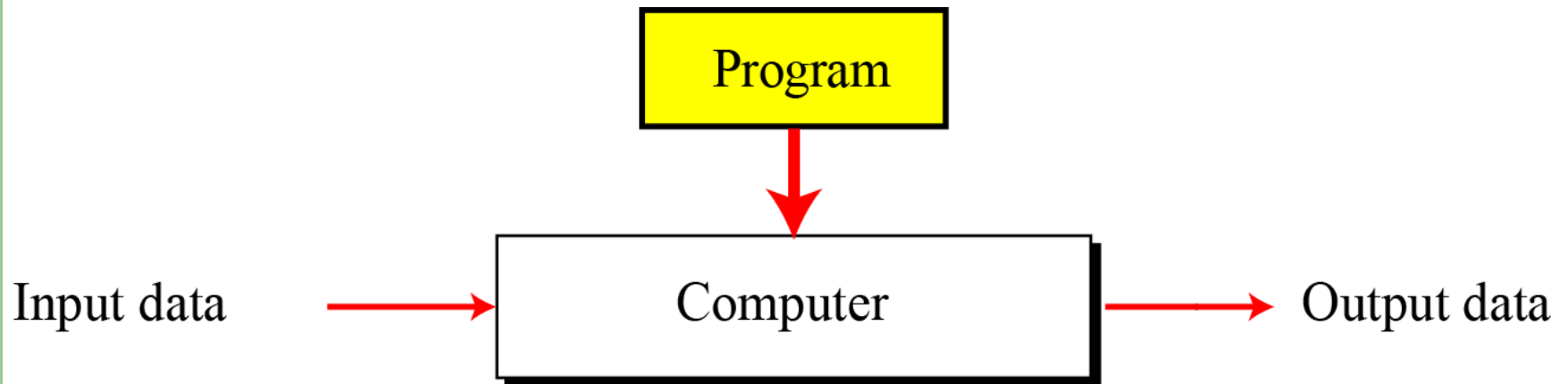

Figure 1.2 A computer based on the Turing model

An Example

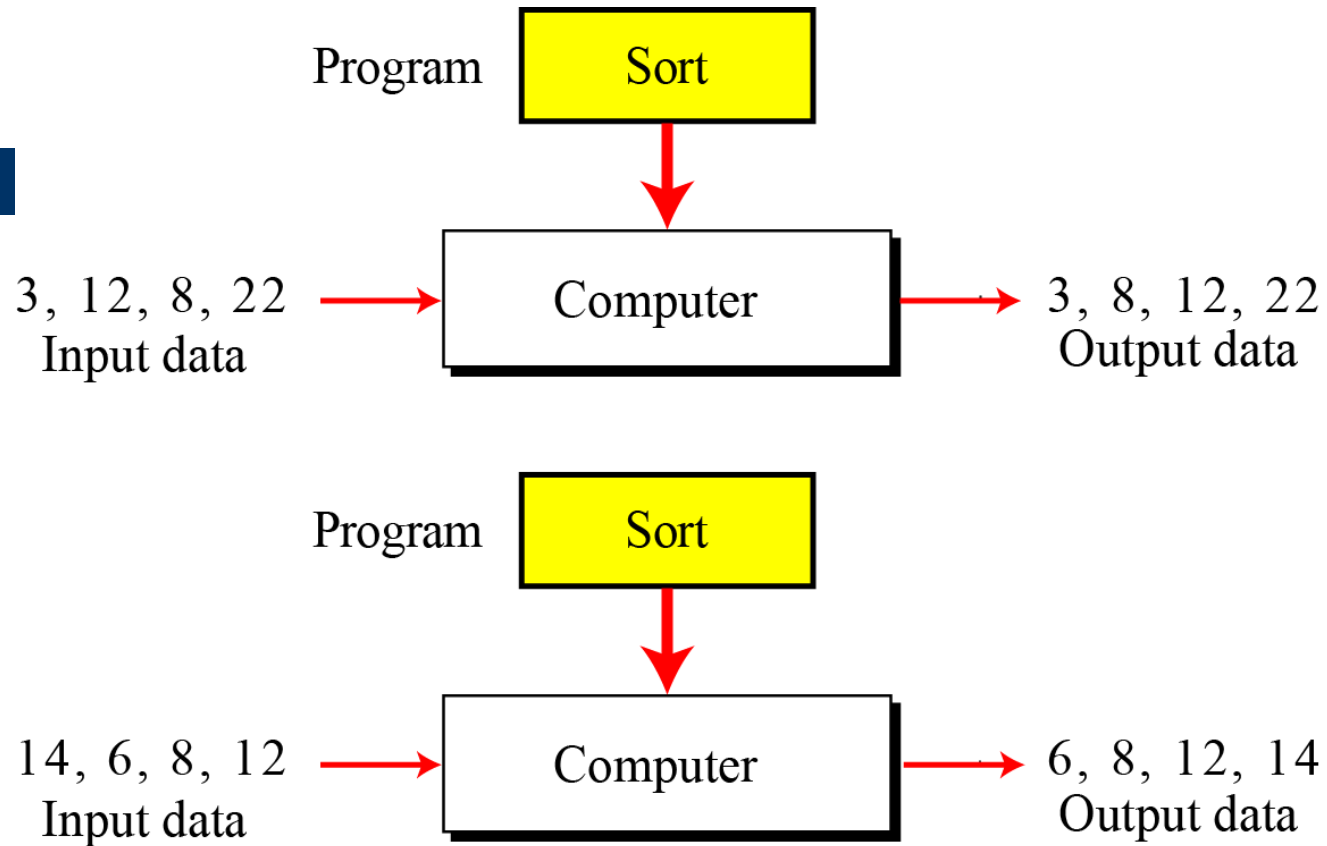

Figure 1.3 The same program, different data

Another Example

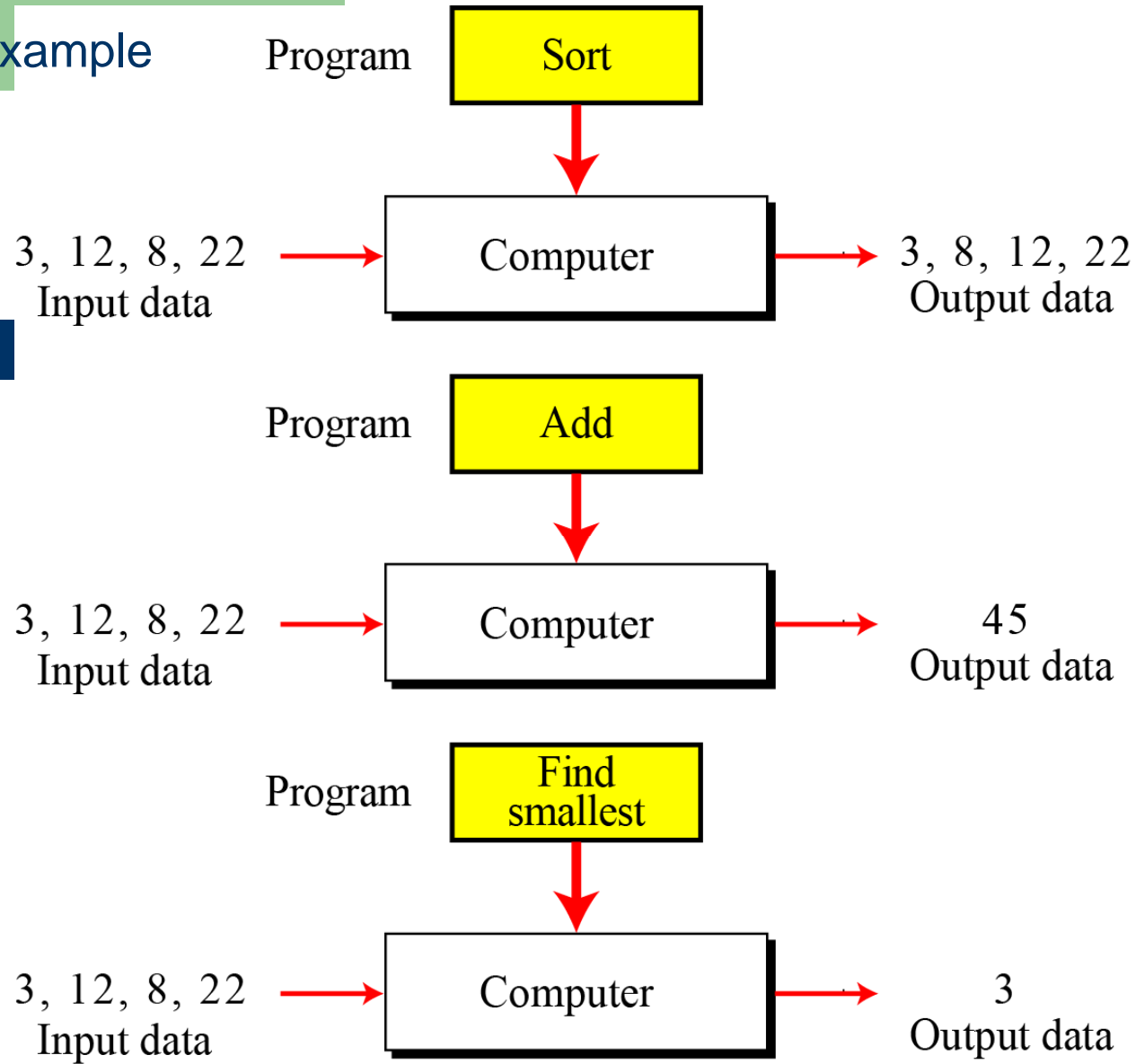

Figure 1.4 The same data, different programs

The Universal Turing Machine

- A **Universal Turing Machine**, a machine that can do any computation if the appropriate program is provided, was the first description of a modern computer.
- It can be proved that a very powerful computer and a universal Turing machine can compute the same thing.
- We need only provide the data and the program—the description of how to do the computation—to either machine.
- In fact, a Universal Turing Machine is capable of computing anything that is computable.

1-2 von Neumann Model

Overview

- Computers built on the Turing universal machine store data in their memory.
- Around 1944–1945, **John von Neumann** proposed that, since program and data are logically the same, programs should also be stored in the memory of a computer.

von Neumann Model

- Every computer today is based on the **von Neumann Model**.
- It is based on 3 ideas:
 1. **Four subsystems**
 2. **Stored Program Concept**
 3. **Sequential Execution of Instructions**

Four Subsystems

- **Memory** – the storage area of programs and data.
- **ALU** – arithmetic/logic operations take place
- **Control Unit** – control Memory, ALU, and I/O
- **I/O** – accept input data/send output data

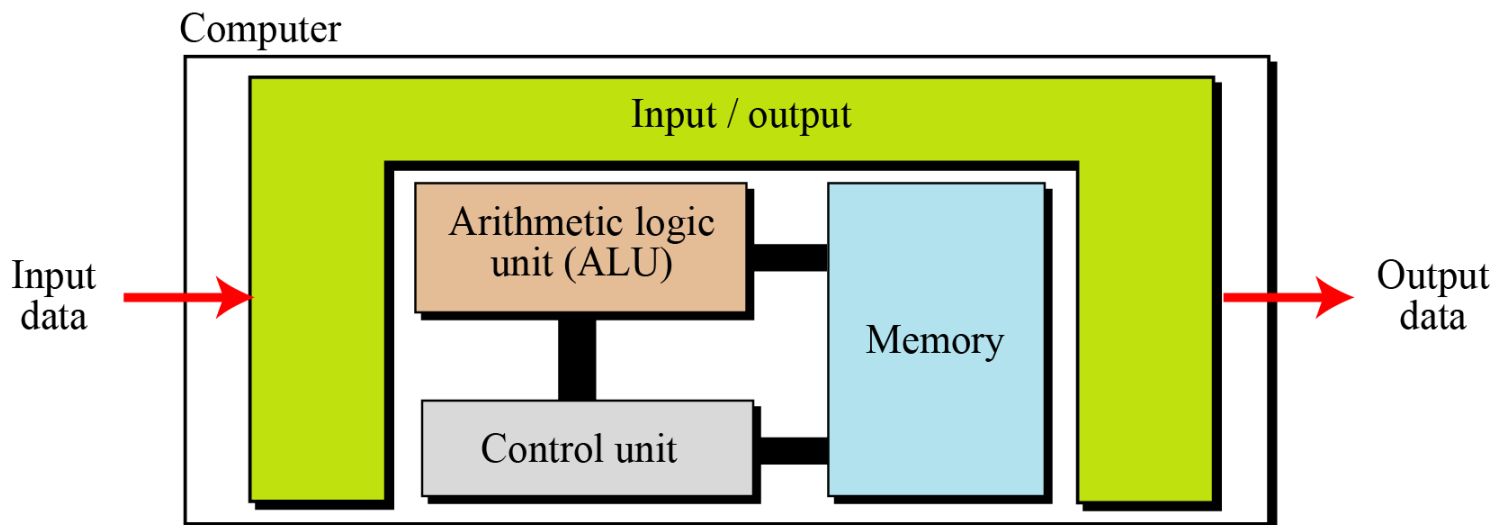

Figure 1.5 The von Neumann model

Stored Program Concept

- The von Neumann model states that the **program** must be stored in memory.
- The memory of modern computers hosts both
 - a **program**
 - its corresponding **data**

Sequential Execution of Instructions

- A program is made of a finite number of instructions.
- The control unit
 - **fetches** one instruction from memory
 - **interpret** it
 - **execute** it
- The instructions are executed one after another.

1-3 Computer Components

Overview

- A computer is made up of three components: **computer hardware**, **data**, and **computer software**.
- Computer hardware today has four components under the von Neumann model

CPU

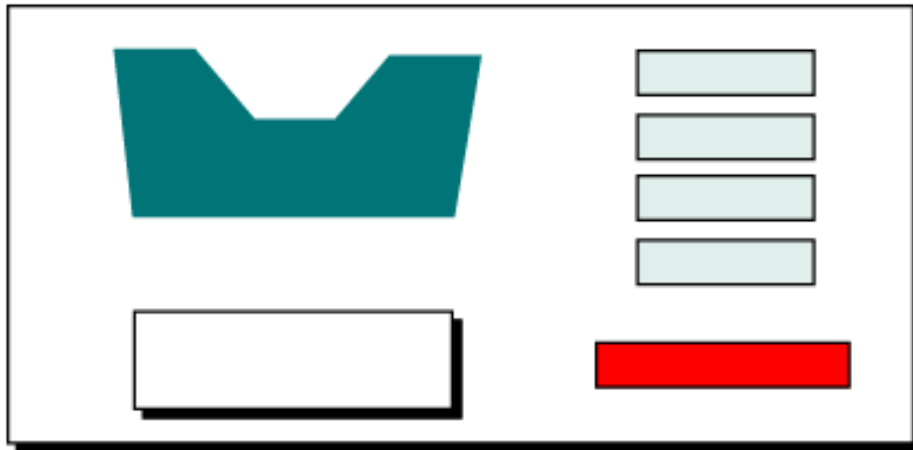

Memory

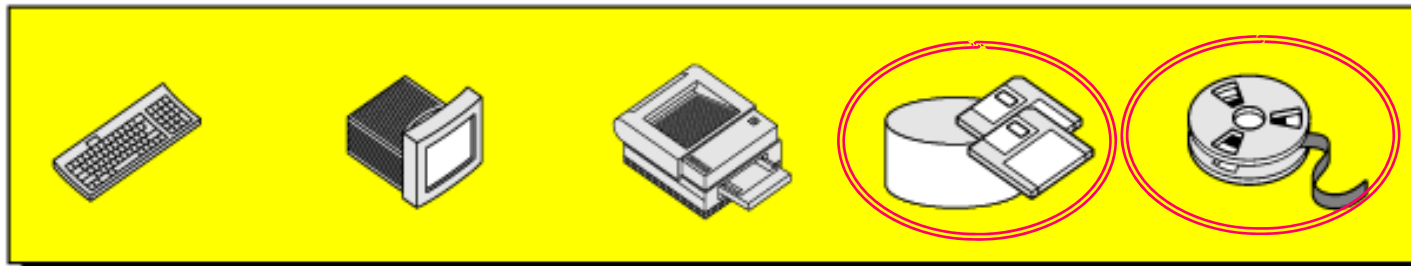
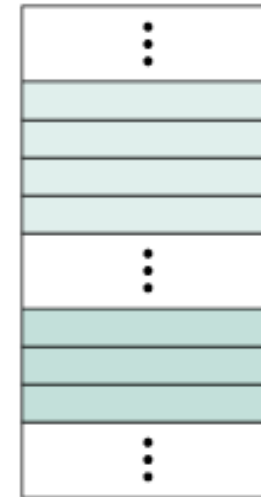

Input/Output

Computer Hardware

Storing Data

- Store data in the form of an electrical signal, specifically its **presence** or **absence**.
- This implies that a computer can store data in one of two states.
- **Binary** number system

Data Organization

- Although data should be stored only in one form (a **binary pattern**) inside a computer, data outside a computer can take many forms.
- Data come in different forms:
 - Numbers
 - Text
 - Images
 - Audio
 - Video

Requirements of von Neumann model

1. The programs must be *stored in memory*. (Fig. 1.6)
2. The programs must be *a sequence of instructions*. (Fig. 1.7)

1. Input first data item into memory.
2. Input second data item into memory.
3. Add the two together and store the result in memory.
4. Output the result.

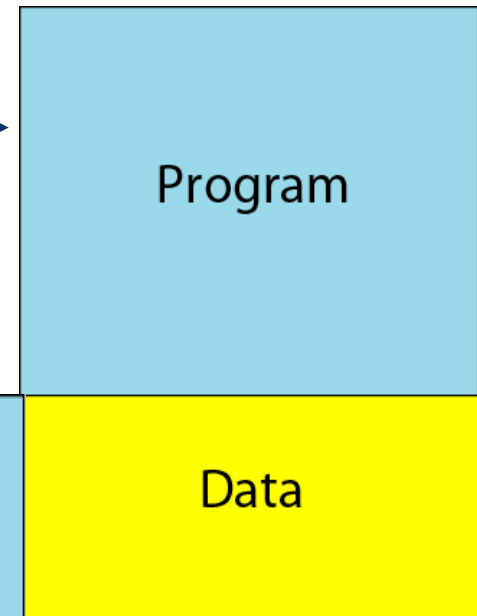

Memory

Program

Algorithms

- A programmer should
 - first solve the problem in a step-by-step manner and then
 - try to find the appropriate sequence of instructions that solves the problem.
- *The step-by-step solution* is called an algorithm.

Operating Systems

- An operating system originally worked as a **manager** to facilitate access of the computer components for a program.

1-4 History

Before 1950

- Mechanical machines (before 1930)
- Early electronic computers (1930-1950)
- **ENIAC** (Electronic Numerical Integrator and Calculator)
first general-purpose, totally electronic computer
University of Pennsylvania, **1946**

1950

- The preceding computers used memory only for storing data.
- EDVAC
the first computer based on von Neumann's idea,
University of Pennsylvania, 1950

Computer generations (1950-present)

- First generation (1950-1959)
vacuum tubes
- Second generation (1959-1965)
transistors,
High-level languages(FORTRAN, COBOL)
- Third generation (1965-1975)
IC(Integrated Circuit),
Minicomputer, software industry was born
- Fourth generation (1975-1985)
VLSI,
microcomputer
- Fifth generation (1985-)
laptop and palmtop computer

Microcomputer

- Microcomputers are designed to be used by individuals, whether in the form of PCs, workstations or notebook computers.
- A microcomputer contains
 - a CPU on a microchip (the microprocessor),
 - a memory system (typically ROM and RAM),
 - a bus system and
 - I/O ports,
- typically housed in a motherboard.

1-5 Social and Ethical Issues

Social issues

- **Dependency**
 - Some people think that computers have created a kind of dependency, which makes people's lives more difficult.
- **Social Justice**
 - Using computers at home is a luxury benefit that not all people can afford.
- **Digital Divide**
 - The concept divides society into two groups: those who are electronically connected to the rest of society and those who are not.

Ethical issues

- **Privacy**
 - Much needs to be done to make this type of communication private.
- **Copyright**
 - The Internet has created opportunities to share ideas, but has also brought with it a further ethical issue: electronic copyright.
- **Computer Crime**
 - Computers and information technology have created new types of crime.

1-6 Computer Science as a Discipline

Computer Science as a Discipline

- We can divide computer science into two broad categories: systems areas and applications areas.
- This book is a breadth-first approach to all these areas.

I Foundations of Computer Science 2. Slide 101. Computers: a child can use them; NOBODY can fully understand them Master complexity through levels of abstraction Focus on 2 or 3 levels at most! Recurring issues: • what services to provide at each level • how to implement them using lower-level services • the interface: how the two levels should communicate. A basic concept in computer science is that large systems can only be understood in levels, with each level further subdivided into functions or services of some sort. The interface to the higher level should supply the advertised services. as mathematical foundation of computer science, this book present a artificial intelligence Concrete Mathematics: A Foundation for Computer Science. 640 Pages•2000•11.25 MB•9,661 Downloads. called The Art of Computer Programming, and in writing the Concrete Mathematics: A Foundation Theory of Computer Science (Automata, Languages and Computation) Third Edition.• Science Theoretical and Mathematical Foundations of Computer Science - ICTMF 2011 (Communi Python Programming: An Introduction to Computer Science. 261 Pages•2012•1.2 MB•112,897 Downloads. Python Programming: An Introduction to Computer Science John M. Zelle, Ph.D. Version 1.0rc2 Fall The Essential Rumi by Coleman Barks. Foundations of Computer Science: What are they and how do we teach them? Viera K. Proulx, Richard Rasala and Harriet Fell.• The role of the first year curriculum in computer science is to. lay the foundations for becoming a professional in the field. We examine the ways in which the changing nature of computer. science influences our teaching methods, our view of which. concepts are fundamental, and the overall sense of what it takes. to become a successful computer scientist. Foundations of Computer Science covers subjects that are often found split between a discrete mathematics course and a sophomore-level sequence in computer science in data structures. It has been our intention to select the mathematical foundations with an eye toward what the computer user really needs, rather than what a mathematician might choose. We have tried to integrate eectively the mathematical foundations with the computing. We thus hope to provide a better feel for the soul of computer science than might be found in a programming course, ix. x PREFACE. a discrete mathematics course,